

主轴轴承

d 55-75mm-B71912-E-T-P4S

参数信息:

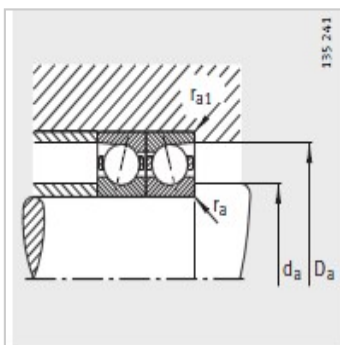
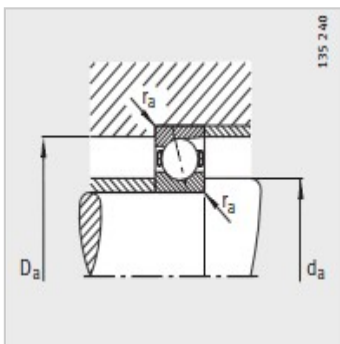
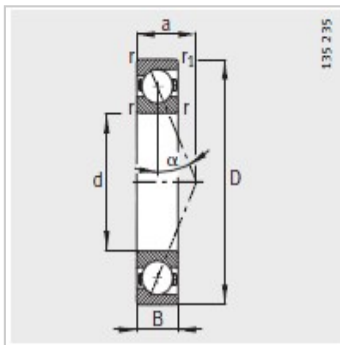
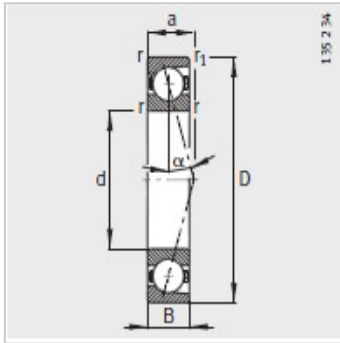

型号 :	B71912-E-T-P4S
质量m kg :	0.195

尺寸mm :	
d :	60
D :	85
B :	13
rmin :	1
r min :	1
a :	23

安装尺寸mm :	
dh12 :	65
DH12 :	80.5
rmax :	0.6
rmax :	0.6

基本额定载荷N :	
动载荷 :	22800
静载荷 :	21600
疲劳极限载荷/N :	1560

极限转速 :	
n脂 :	14000
n油 :	22000

