

机加工滚针轴承

D 10-47mm-RNAO6X13X8-TV

参数信息:

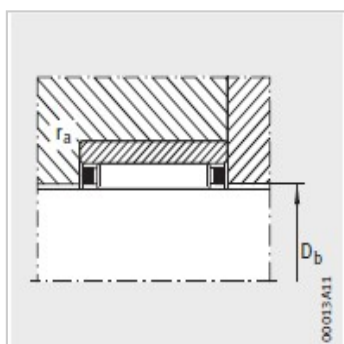
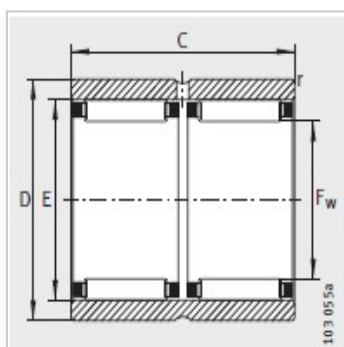
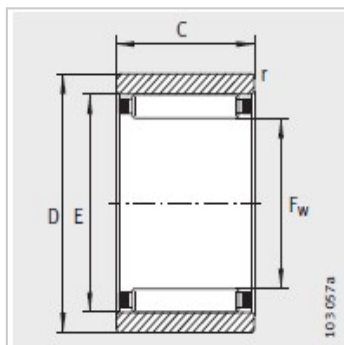

型号 :	RNAO6X13 X8-TV
X-life :	XL
质量 g :	6

尺寸mm :

F :	6
D :	13
C :	8
E :	9
r min :	0.3

安装尺寸mm :

D :	6.3
d :	8.7
D :	9.3
r max :	0.3

基本额定载荷N :

动载荷 :	2950
静载荷 :	2280
疲劳极限载荷/N :	355
极限转速 :	36500
参考转速 :	48500

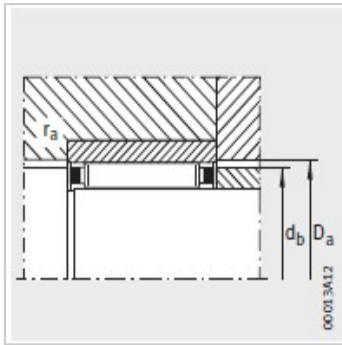

: